



Radiar AF10

2 channel AC powered 0-10V
fixture controller with inbuilt relay



SELV



openADR ALLIANCE

Product Overview

Radiar AF10, the dual-channel dimming/ tunable AC fixture controller is a part of the Lumos Controls ecosystem.

The device is easy to mount in an electrical junction box or compatible fixtures. The device has dual channel 0-10V independent output to control intensity and correlated color temperature(CCT) and it has a 0-3 VDC input channel and 12VDC aux output to integrate with third-party sensors.

The device with a 3A relay for load control saves time designing an intelligent lighting network that is in tune with your circadian rhythm. It can be quickly commissioned, configured, and controlled from any mobile device and can be connected to Lumos Controls cloud for data analytics and configuration management.

The Lumos Controls ecosystem comprises controllers, sensors, switches, modules, drivers, gateways, and analytical dashboards. It is listed by the **Design Lights Consortium (DLC)**, qualifying it for energy conservation incentive programs and rebates by utility companies.

Specifications

Electrical

Specifications	Value	Remarks
Input voltage	120-277VAC	Rated input voltage
Input current	3.10A	@Max RF transmtting
Frequency	60Hz	
Load voltage	120-277VAC	
Load current	3A	
Max output wattage	360W	@120VAC
Inrush current	20A	
Surge protection	1kV*	@Line to line bi wave

* 10kV SPD accessory available

Sensor Input

Specifications	Value	Remarks
Voltage range	0-3VDC	digital
Current	1mA	

Features

- Dual channel 0-10V independent output to control intensity and corelated color temperature (CCT)
- Auxiliary 12V/200mA output to power sensors
- 0-3VDC input channel to integrate with third party sensors
- 3A relay for turning on/off dim to 1 drivers
- Standard ½ inch chase nipple allows easy mounting to a junction box or compatible fixture
- Zero downtime Over-the-Air (OTA) firmware updates

0-10V Output

Specifications	Value	Remarks
Number of channels	2	
Voltage range	0-10VDC	tolerance: ±0.2V
Current	10mA	source current per channel
Dimming range	0-100%	1000 steps resolution
Dimming curve	linear (default)/ logarithmic	

Auxiliary Output

Specifications	Value
Voltage	12VDC
Current	200mA

Bluetooth

Specifications	Value	Remarks
Frequency range	2402-2480MHz	
Max output power	8dBm	
Receive sensitivity	-92dBm	
Connection distance (device to device)	45m(147.6 ft)	Vary depending on the installation enviorment

Environmental

Specifications	Value
Operating temperature	-30 to 55°C (-22 to 122°F)
Case temperature	80°C (176°F)
Relative humidity	5-95% non-condensing

Mechanical

Specifications	Value	Remarks
Dimension	3.22 x 1.71 x 1.25 (inch) 81.79 x 43.43 x 31.75 (mm)	L x W x H
Weight	93g (3.28oz)	
Case material	PC	Blue color
Flammability rating	UL 94 V-0	

Wire Description

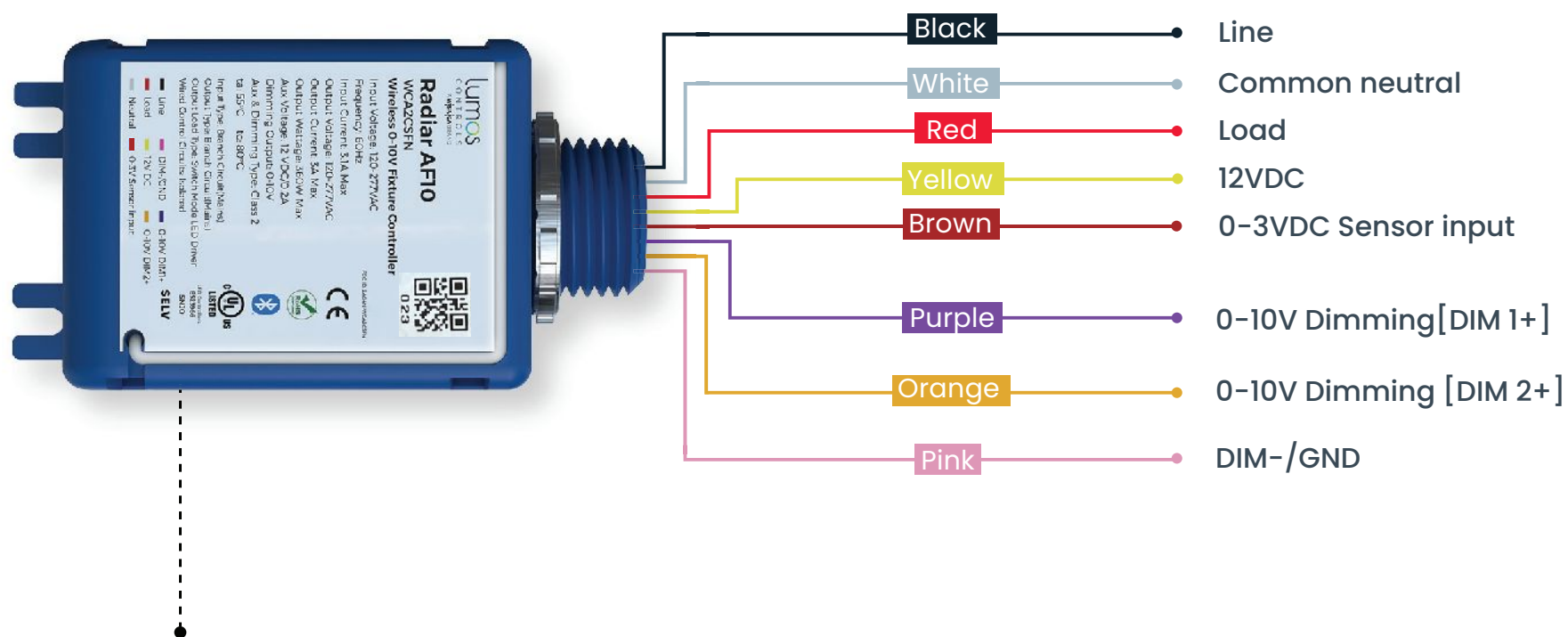

100mm wire antenna

Antenna Information

Frequency range	2.4GHz-2.5GHz
Impedance	50 Ω Nominal
VSWR	2:1 Max
Gain (Peak)	3dBi

NAME	COLOR	GAUGE	RATING	DESCRIPTION
Line	Black	18AWG (0.75mm ²)	600V	120-277VAC
Common neutral	White	18AWG (0.75mm ²)	600V	Common neutral
Load	Red	18AWG (0.75mm ²)	600V	3A@120/277VAC
12VDC	Yellow	22AWG (0.34mm ²)	300V	12VDC auxiliary output
0-3V Sensor input	Brown	22AWG (0.34mm ²)	300V	0-3V input for sensor
0-10V DIM1+	Purple	22AWG (0.34mm ²)	300V	0-10V output for intensity
0-10V DIM2+	Orange	22AWG (0.34mm ²)	300V	0-10V output for CCT
DIM-/GND	Pink	22AWG (0.34mm ²)	300V	Common ground

Product Dimensions

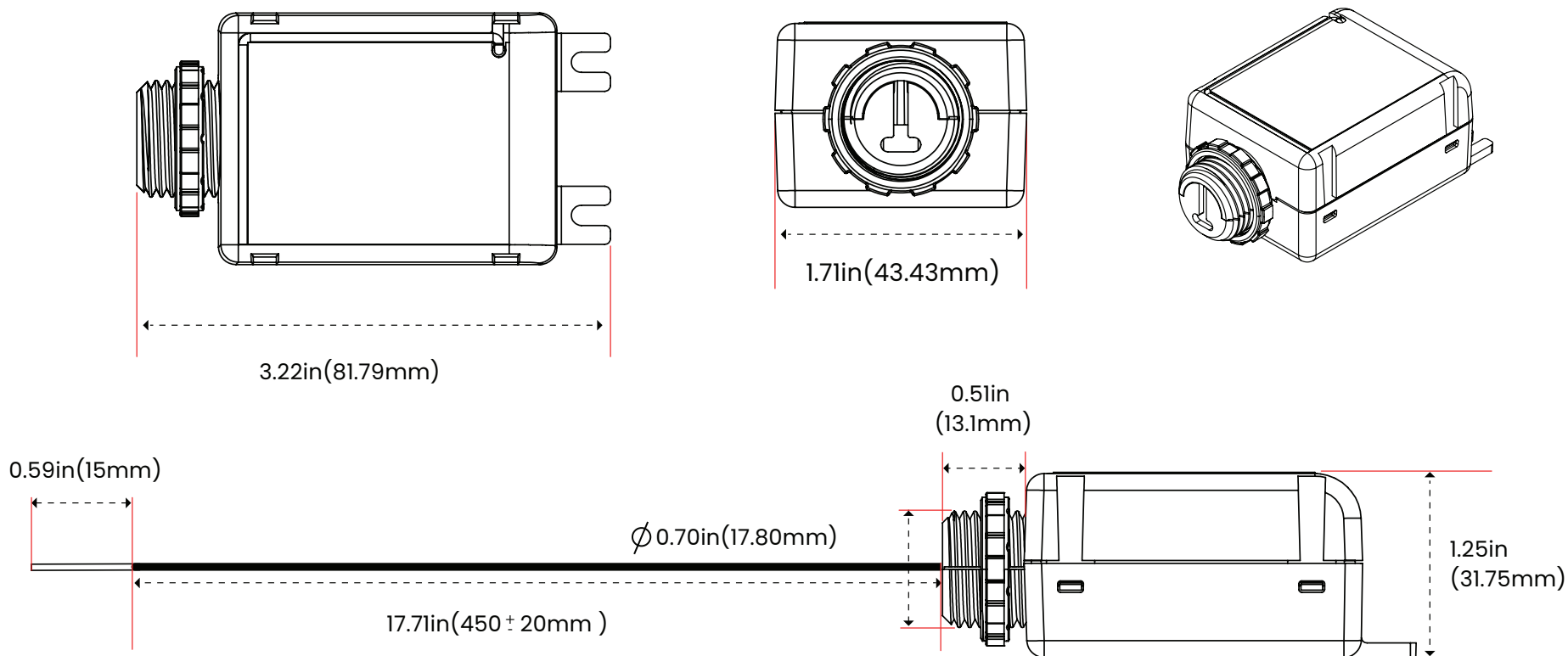

Size comparison with a standard credit card

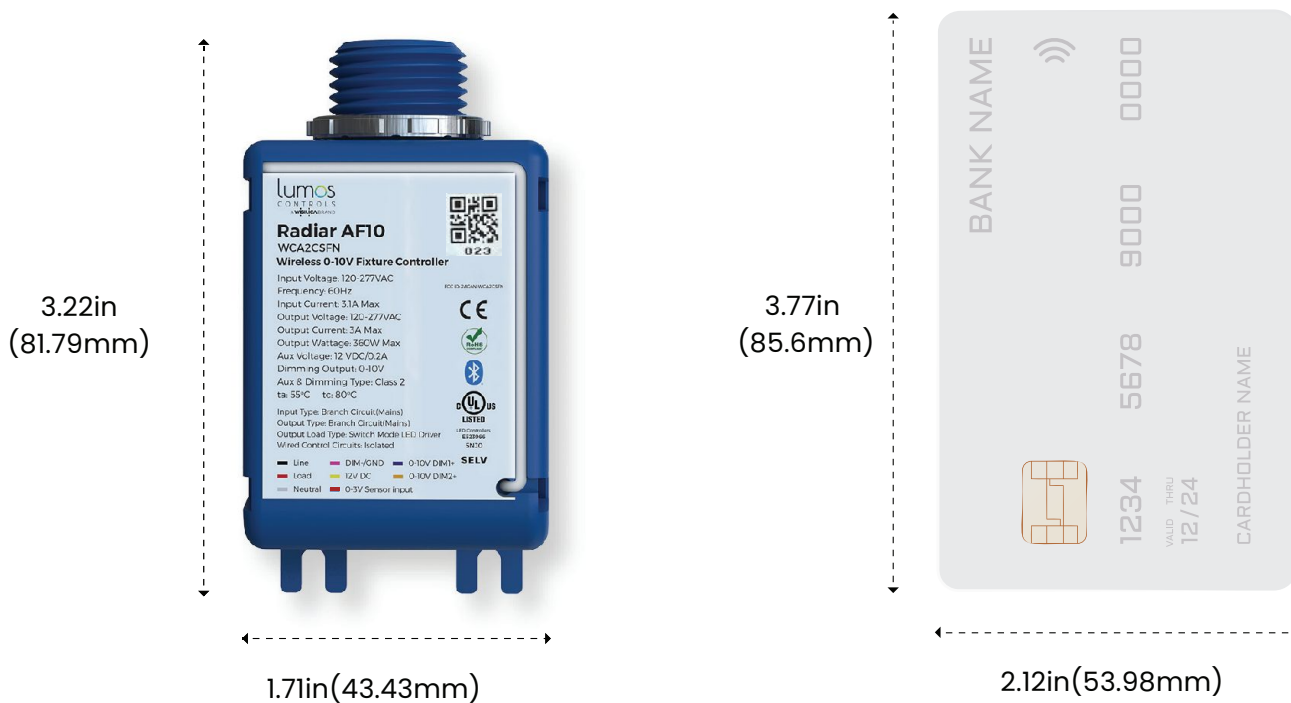

Wiring

Radiar AF10 can be installed in a deep junction box or fixture with standard ½ inch knockouts

1. Configuring Radiar AF10 for dimming, tuning and an external sensor control

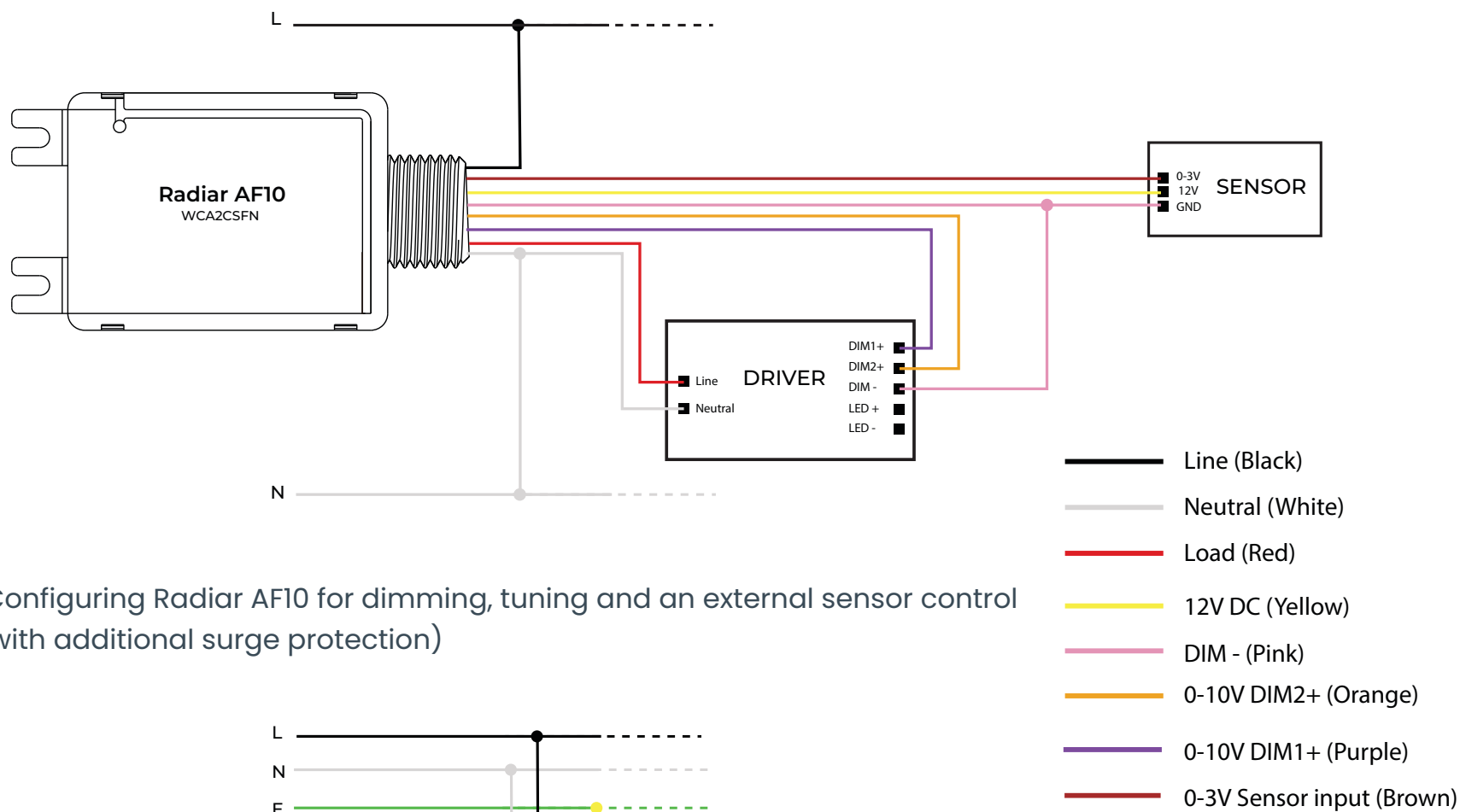

2. Configuring Radiar AF10 for dimming, tuning and an external sensor control (with additional surge protection)

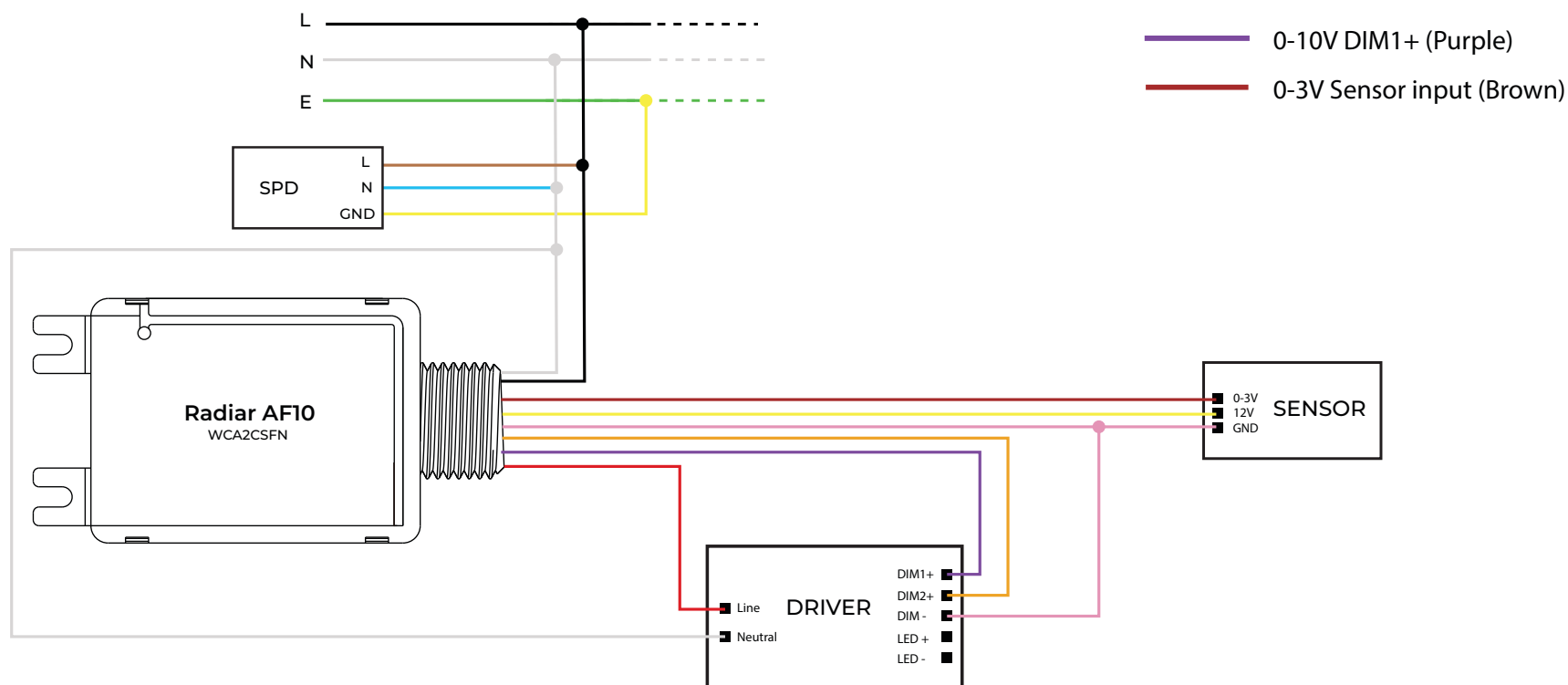

Smart Ecosystem

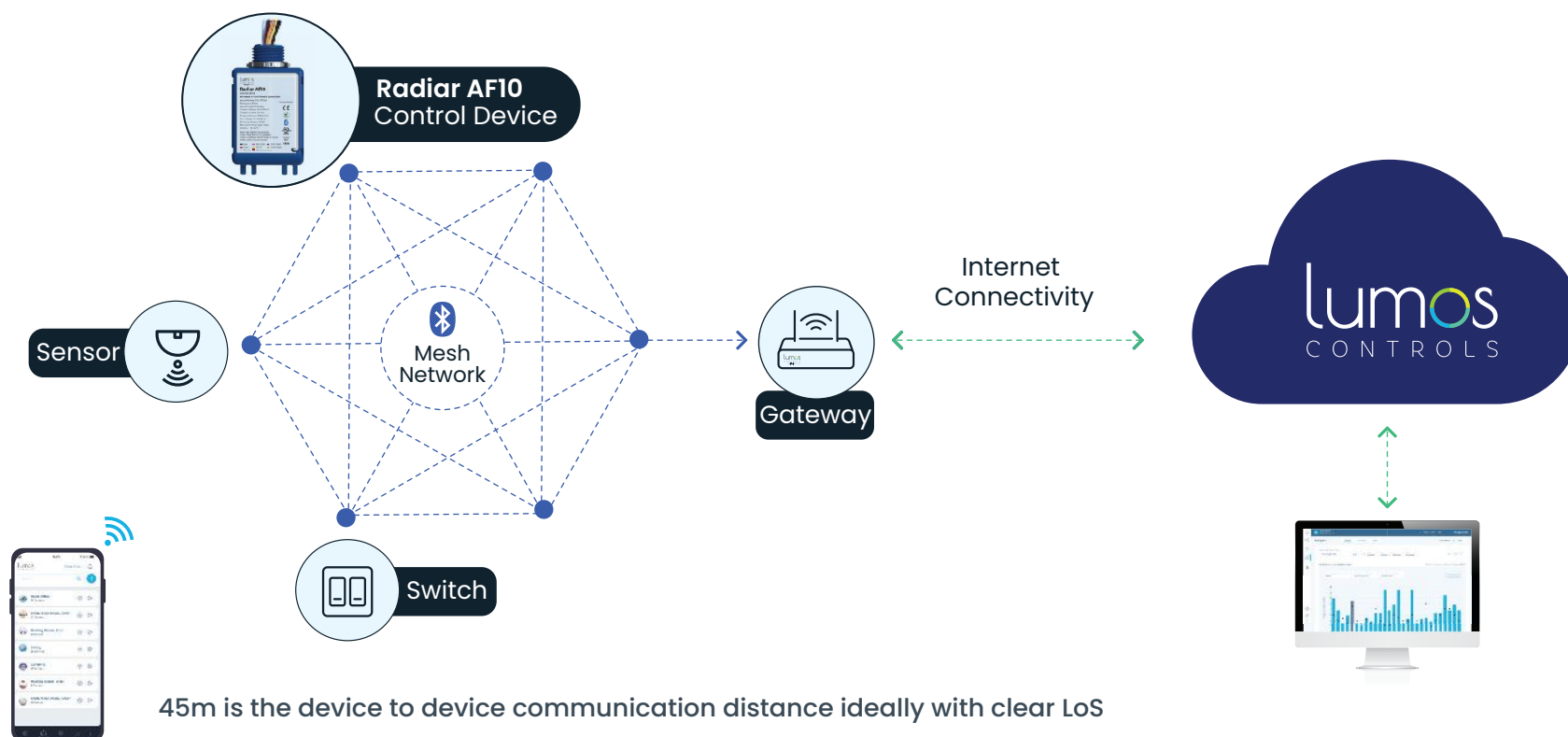

Certifications	Details
CE	<p>Article 3, RED 2014/53/EU</p> <p>EMC test standards</p> <p>ETSI EN 301 489-1 V2.2.3(2019-11) ETSI EN 301 489-17 V3.2.4(2020-09) EN 55032: 2015/A11:2020 EN 55035: 2017+A11 :2020</p> <p>Safety test standard</p> <p>EN 61347-2-11:2001+A1:2019; EN 61347-1:2015+A1:2021 EN 62493:2015;</p> <p>Radio test standard</p> <p>ETSI EN 300 328 V2.2.2 (2019-07)</p> <p>Health test standard:</p> <p>EN 62479: 2010 EN 50663: 2017</p>
RoHS 2.0	RoHS Directive (EU) 2015/863 amending Annex II to Directive 2011/65/EU
cULus	E523966, Light-emitting-diode controllers (FLTJ)
FCC	FCC Rule Part 15C ID: 2AG4N-WCA2CSFN
Bluetooth	Declaration ID: D059551

Items included in the package box

- Radiar AF10
- User manual
- Metallic locknut
- Wire nuts

Application

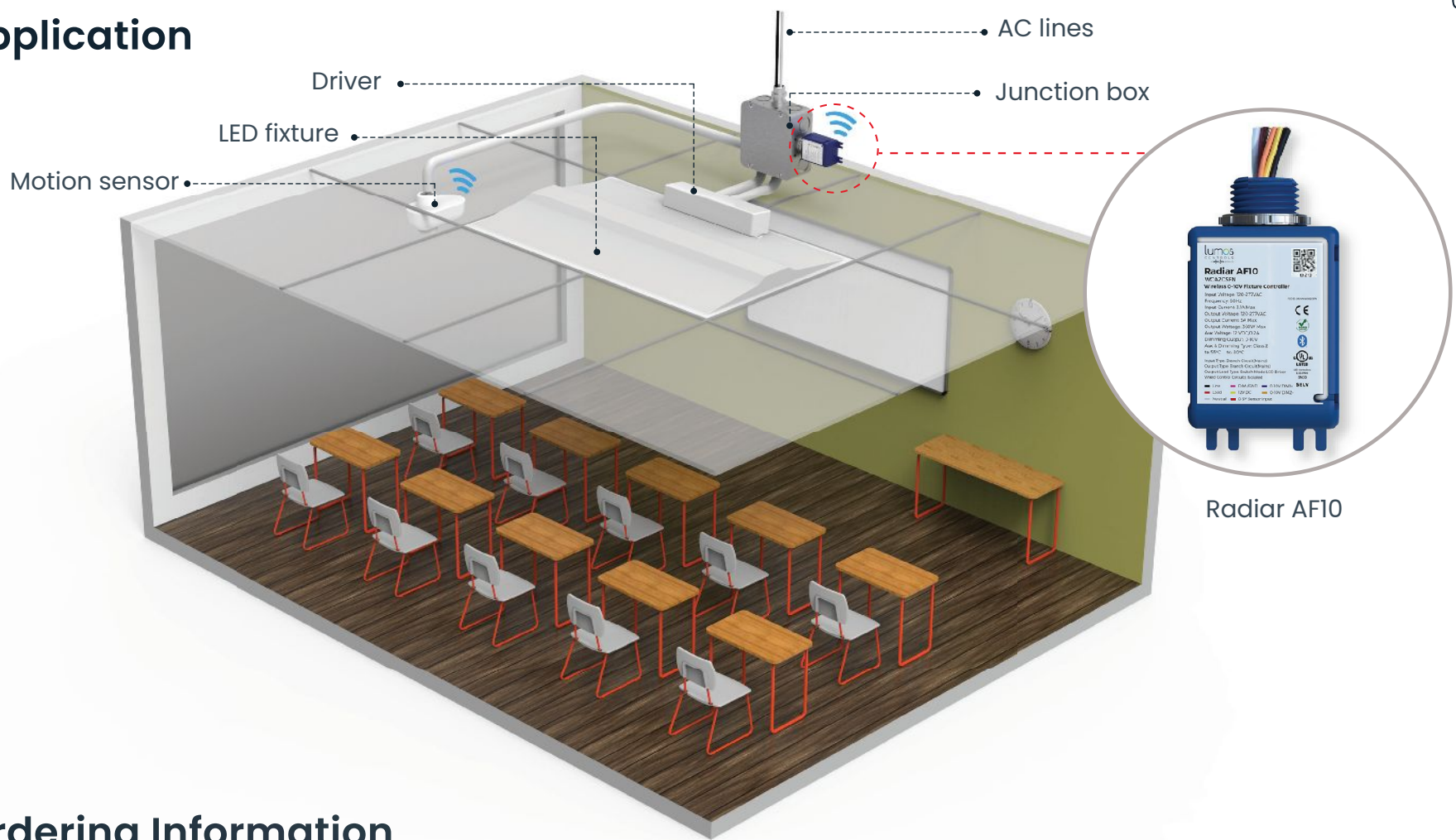

Ordering Information

Product Code	Product Name	Product Description	Communication	Voltage Rating	Sensor Input	Output Channel	Aux Power	Relay Control
WCA2CSFN	Radiar AF10	Wireless 0-10V dual channel dimming AC powered fixture controller	BLE5.2	120-277VAC	0-3VDC	0-10V 2 Channels	12VDC	3A

Accessories

Product Code : SPD1PRIP67	Product Description : LED Surge Protection Device	SPD offers protection up to 10kV
---------------------------	---	----------------------------------

The Bluetooth® word mark and logos are registered trademarks owned by Bluetooth SIG, Inc. and any use of such marks by WiSilica Inc. is under license. Other trademarks and trade names are those of their respective owners.



20321 Lake Forest Dr D6,
Lake Forest, CA 92630

 www.lumoscontrols.com

 +1 949-397-9330